



ROUPEIRO NEW PREMIUM 08 PTS
Código: 8728

Benetil
Móveis

Av. Jesus Candian, 395 - B. Mangueira Rural
Telefax (32) 3539-5350
CEP 36500-000 - Ubá - Minas Gerais
www.benetil.com.br

DETALHES IMPORTANTES

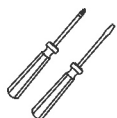

32 3539.5350
www.benetil.com.br

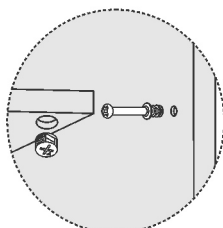

Minifix

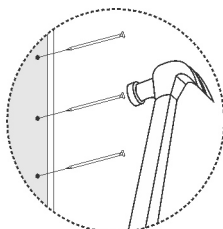

Costas Pregadas

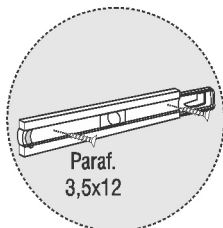

Paraf.
3,5x12

Corrediça Telecópica

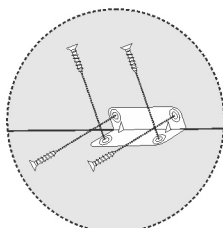

Cantoneira 4 Furos

COMPONENTES

NUM.	PEÇA	QUANT.
01	LATERAL ESQUERDA	01
02	RODAPÉ MAIOR	02
03	RODAPÉ MENOR	03
04	LATERAL DIREITA	01
05	BASE	01
06	DIVISÃO LATERAL	02
07	DIVISÃO MENOR INFERIOR	01
08	DIVISÃO MAIOR SUPERIOR	01
09	PRATELEIRA CENTRAL MAIOR	01
10	PRATELEIRAS LATERAIS	06
11	TAMPO SUPERIOR	01
12	VISTA SUPERIOR	01
13	PORTAS	08
14	COSTAS VERTICAL	03
15	FRENTE GAVETAS	04
16	LATERAL DE GAVETAS	08
17	TRASEIRO GAVETAS	04
18	FUNDO GAVETAS	04

ATENÇÃO: EM CASO DE ASSISTÊNCIA, VERIFICAR O NÚMERO DO LOTE DE PRODUÇÃO, NO TOPO DAS PEÇAS E NA ETIQUETA DA CAIXA DO PRODUTO.

RESERVAMO-NOS O DIREITO DE EFETUAR MODIFICAÇÕES TÉCNICAS OU DE MATERIAIS SEM PRÉVIO AVISO.

RELAÇÃO DE FERRAGENS EM TAMANHO REAL (MEDIDA EM MILÍMETRO).



A - PARAF. 3,5x14

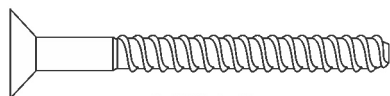

B - PARAF. 5x40

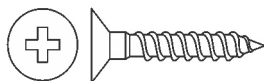

C - PARAF. 4,0x25

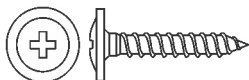

D - PARAF. 3,5x20 FLANGEADO

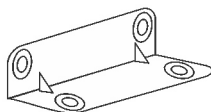

E - CANTONEIRA 4 FUROS

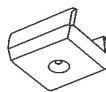

F - SAPATA DE ENCAIXE



H - FIXADOR DE COSTAS



J - TAMPA ADESIVA

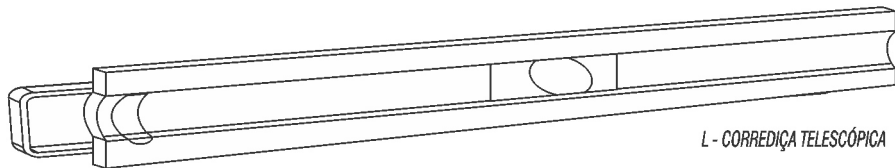

L - CORREDIÇA TELESCÓPICA

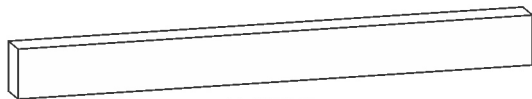

M - PUXADOR

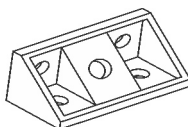

N - CANTONEIRA 4 FUROS

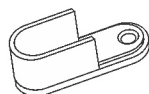

O - SUPORTE CABIDEIRO

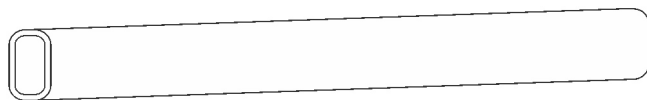

P - CABIDEIRO



Q - CAVILHA 6x30



R - PREGO 10x10

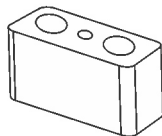

S - ALONGADOR DE CORREDIÇA

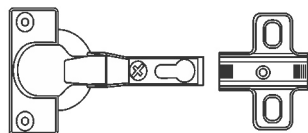

U - DOBRADIÇA

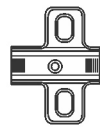

V - CALÇO



UTILIZE A RÉGUA PARA A MEDIÇÃO DOS PARAFUSOS

FAVOR IDENTIFICAR AS PEÇAS E COLOCAR SEUS RESPECTIVOS ACESSÓRIOS

Sequência de Montagem

- 01 - Parafusar peças 3 nos rodapés 2
- Observação: Seguir a furação que vai em cima do rodapé 2 para colocação do rodapé 03 tem que ficar alinhado.
- 02 - Parafusar peças 1 na peça 2.
- 03 - Parafusar peça 4 nas peças 2.

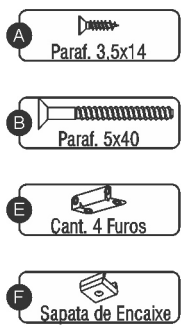

ATENÇÃO COM OS FUROS NA PARTE SUPERIOR DA PEÇA 2 AS PEÇAS 3 TEM QUE ALINHADOS COM OS MESMOS.



ATENÇÃO CASO OPTE PELA COLOCAÇÃO DOS PÉS QUE SÃO VENDIDOS SEPARADAMENTE VER O DESENHO PAGINA 08.

Sequência de Montagem

- 04- Encaixar e Parafuse peça 5 nos rodapés 2 e laterais 1 e 4.
- 05- Encaixar peças 6 e 7 na peça 5.
- 06- Parafusar peça 10 nas peças 1, 4 e 6.

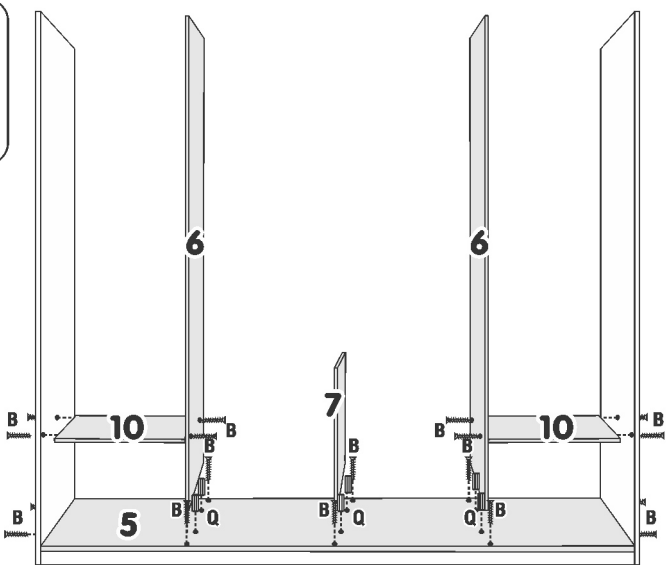
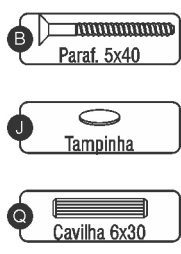

Sequência de Montagem

- 07- Parafusar peça 9 na peça 8.
- 08- Encaixar peça 9 na peça 7 e parafusar nas peças 6.
- 09- Parafusar as peças 10 nas peças 1, 4 e 6

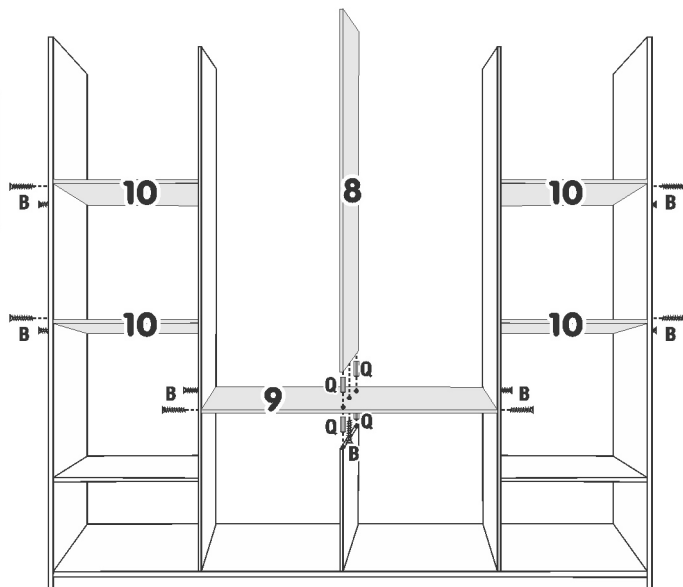
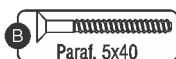

Sequência de Montagem

- 10 - Encaixar e parafusar peça 11 na peças 1, 4, 6 e 8 conforme desenho ao lado.

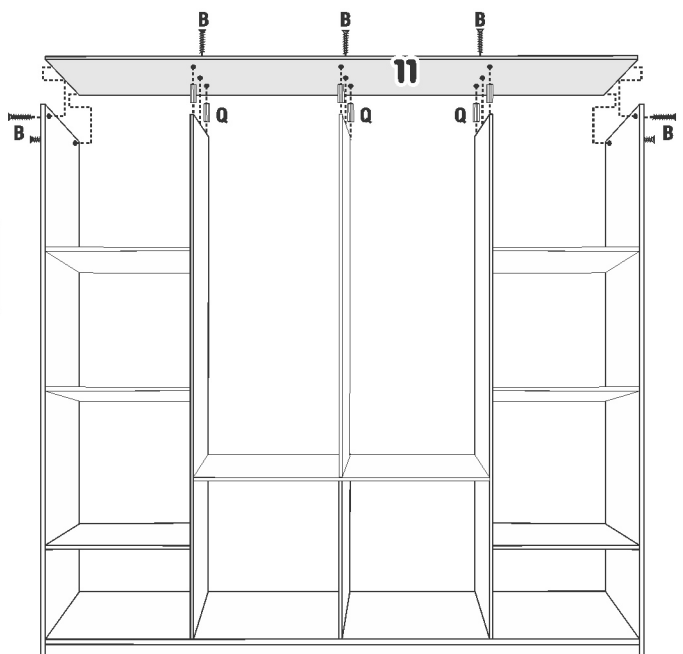
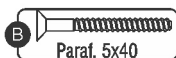

Sequência de Montagem

- 11 - Parafusar peça 12 nas peças 01, 04 e também na peça 11.
- 12 - Fixar os distanciadores plásticos, conforme desenho.

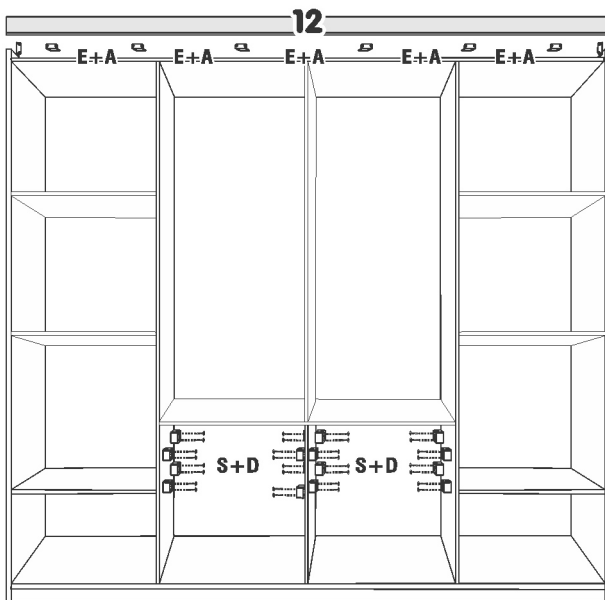

Sequência de Montagem

- 13 - Montar os cabideiros com os suportes.
- 14 - Parafusar as corrediças.

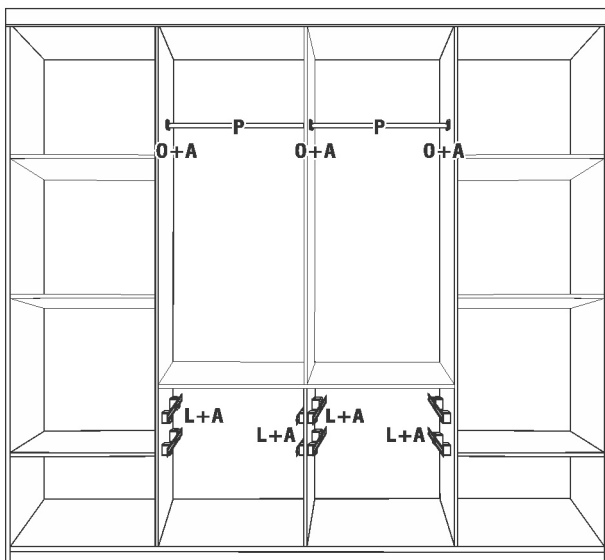
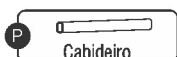
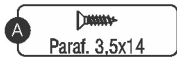

Seqüência de Montagem

15 - Pregiar as Costas 14.

OBS.: Acertar as costas para melhor esquadramento do móvel.

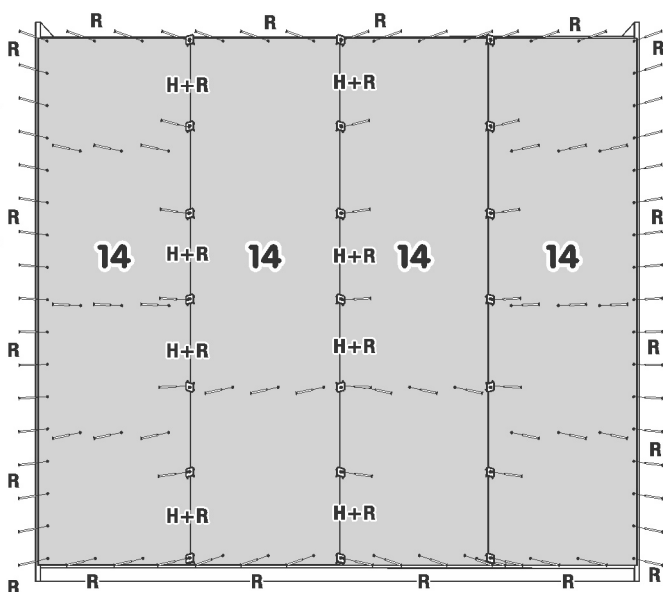
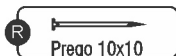
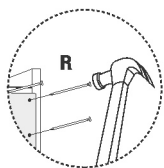

Seqüência de Montagem

16 - Montar e fixar as Portas 13.

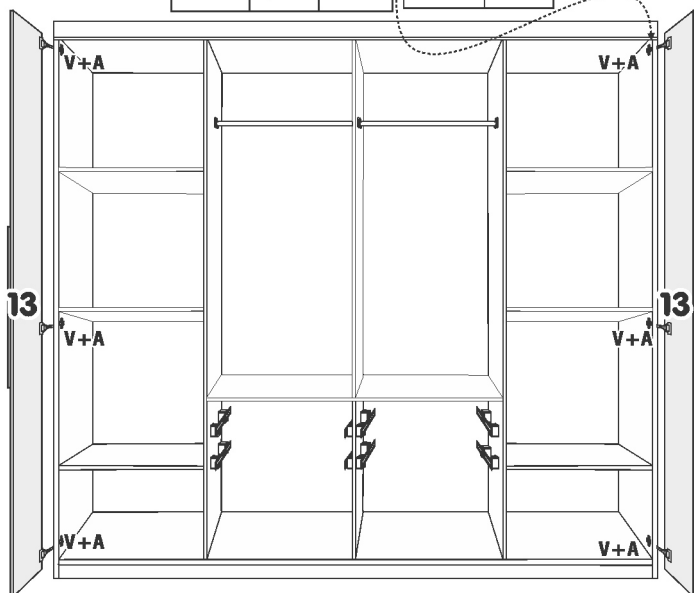
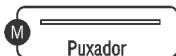
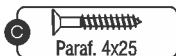
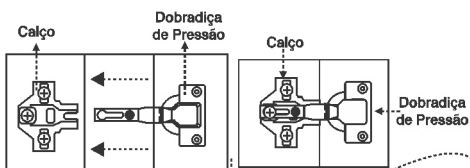
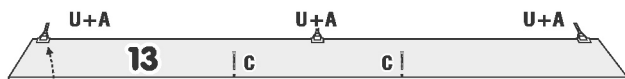
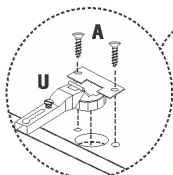

Sequência de Montagem

- 17 - Parafusar as cantoneiras nas peças 16;
- 18 - Parafusar as peças 16 na peça 15;
- 19 - Parafusar a peça 17 nas peças 16;
- 20 - Parafusar peça 18 nas peças 16 e 17 conforme desenho abaixo, ajustando para melhor esquadramento da gaveta;
- 21 - Parafusar as corredeiras na lateral da peça 16;

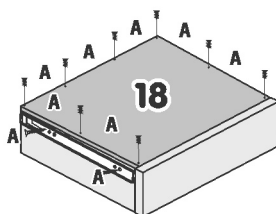
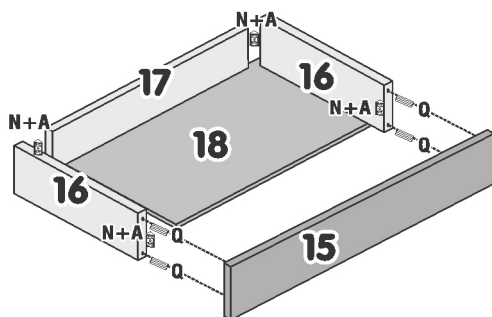

Montagem sem Pé Opcional (Fica dessa forma com sapata e Cantoneira)

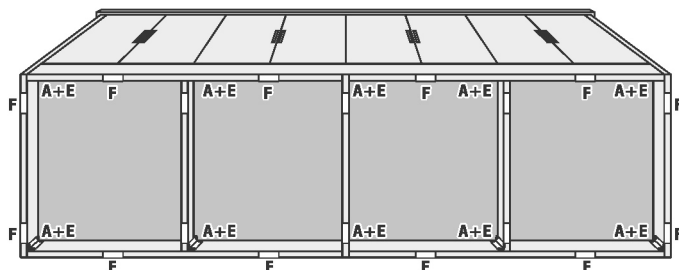

Montagem Pé Opcional (Kit Pé vendido separadamente)

Sequência de Montagem

- 22 - Caso opte pela colocação dos pés, RETIRE A CANTONEIRA DE METAL e faça o seguinte: fixar os pés no lugar das cantoneiras conforme o desenho abaixo.

