

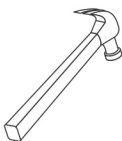

ROUPEIRO MILÃO 04 PTS
Código: 8070

Benetil
Móveis

Av. Jesus Candian, 395 - B. Mangueira Rural
Telefax (32) 3539-5350
CEP 36500-000 - Ubá - Minas Gerais
www.benetil.com.br



☎ 32 3539.5350
www.benitil.com.br

DETALHES IMPORTANTES

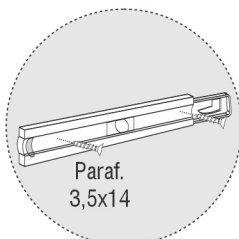

Corrediça Telecópica

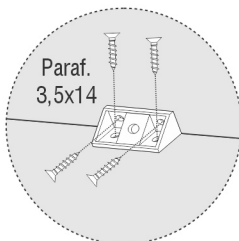

Cantoneira 4 Furos

| COMPONENTES | | |
|-------------|----------------------------|--------|
| NUM. | PEÇA | QUANT. |
| 01 | LATERAL ESQUERDA | 01 |
| 02 | RODAPÉ MAIOR | 02 |
| 03 | RODAPÉ MENOR | 02 |
| 04 | LATERAL DIREITA | 01 |
| 05 | PÉ | 06 |
| 06 | BASE | 01 |
| 07 | DIVISÕES | 01 |
| 08 | PRATELEIRA | 02 |
| 09 | PRATELEIRA CENTRAL RECUADA | 01 |
| 10 | TAMPO INTERMEDIÁRIO | 01 |
| 11 | DIVISÃO MALEIRO | 02 |
| 12 | TAMPO SUPERIOR | 01 |
| 13 | VISTA SUPERIOR | 01 |
| 14 | FRENTE GAVETA | 03 |
| 15 | LATERAIS GAVETA | 06 |
| 16 | TRASEIRO GAVETA | 03 |
| 17 | FUNDOS DE GAVETA | 03 |
| 18 | COSTAS | 03 |
| 19 | PORTAS | 04 |
| | | |
| | | |
| | | |
| | | |
| | | |

ATENÇÃO: EM CASO DE ASSISTÊNCIA, VERIFICAR O NÚMERO DO LOTE DE PRODUÇÃO, NO TOPO DAS PEÇAS E NA ETIQUETA DA CAIXA DO PRODUTO.

RESERVAMO-NOS O DIREITO DE EFETUAR MODIFICAÇÕES TÉCNICAS OU DE MATERIAIS SEM PRÉVIO AVISO.

RELAÇÃO DE FERRAGENS EM TAMANHO REAL (MEDIDA EM MILÍMETRO).



A - PARAF. 3,5x14

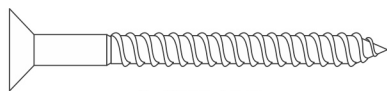

B - PARAF. 4,5x40

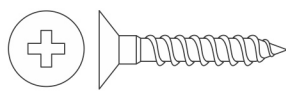

C - PARAF. 4,0x25

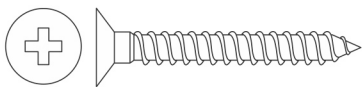

D - PARAF. 4,0x35

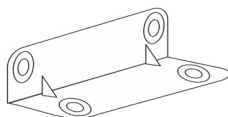

E - CANTONEIRA 4 FUROS



F - SACHÊ DE COLCA

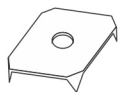

H - FIXADOR DE COSTAS



J - TAMPA ADESIVA

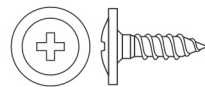

K - PARAF. 3,5x14 FLANGEADO

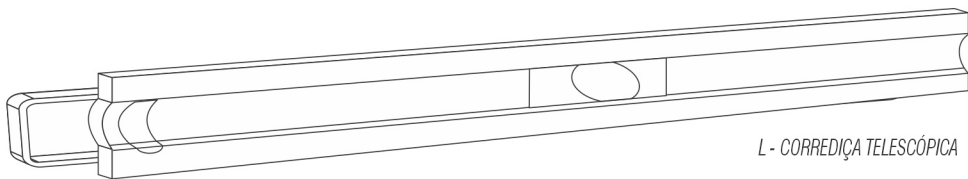

L - CORREDIÇA TELESCÓPICA

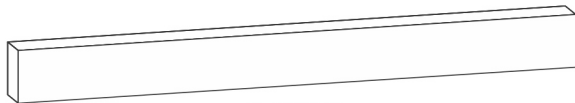

M - PUXADOR

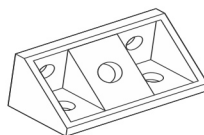

N - CANTONEIRA 4 FUROS

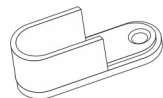

O - SUPORTE CABIDEIRO

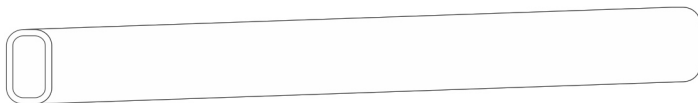

P - CABIDEIRO



Q - CAVILHA 6x30



R - PREGO 10x10

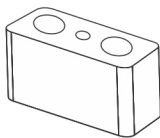

S - ALONGADOR DE CORREDIÇA

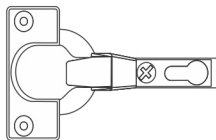

T - DOBRADIÇA

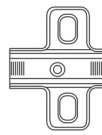

U - CALÇO

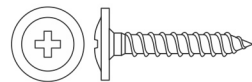

V - PARAF. 3,5x20 FLANGEADO

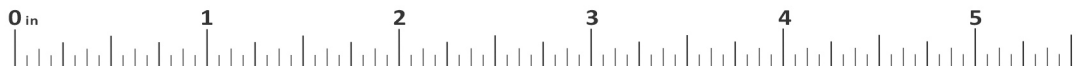

3

UTILIZE A RÉGUA PARA A MEDIÇÃO DOS PARAFUSOS

FAVOR IDENTIFICAR AS PEÇAS E COLOCAR SEUS RESPECTIVOS ACESSÓRIOS

Sequência de Montagem

- 01 - Parafusar peças 1 na peça 2.
- 02 - Parafusar peças 3 nos rodapés 2
- Observação: Seguir a furação que vai em cima do rodapé 2 para colocação do rodapé 03 tem que ficar alinhado.
- 03 - Parafusar peça 4 nas peças 2;
- 04 - Parafusar os Pés 5 nos rodapés 2.

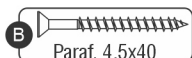

ATENÇÃO COM OS FUROS NA PARTE SUPERIOR DA PEÇA 2 AS PEÇAS 3 TEM QUE ALINHADOS COM OS MESMOS.

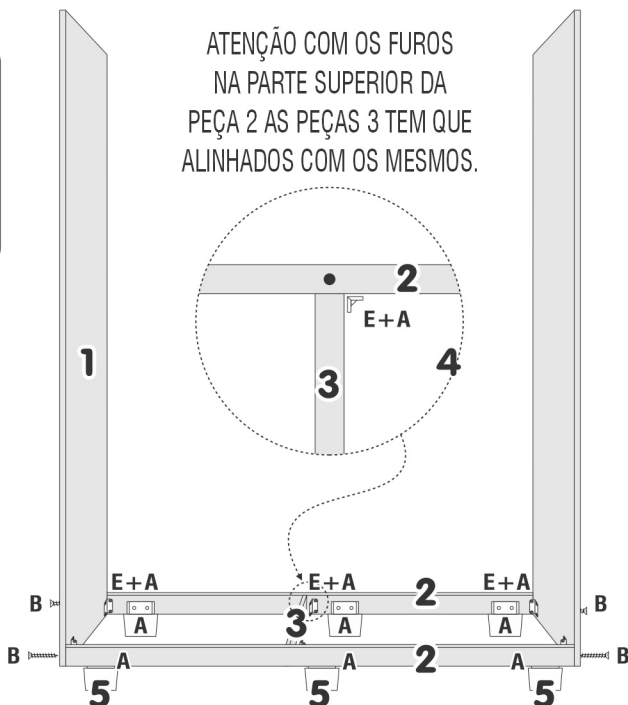

Sequência de Montagem

- 05- Encaixar e Parafuse peça 6 nos rodapés 2 e laterais 1 e 4.
- 06- Encaixar e parafusar peças 7 na peça 6.
- 07- Parafusar peças 8 nas peças 7, 1 e 4.

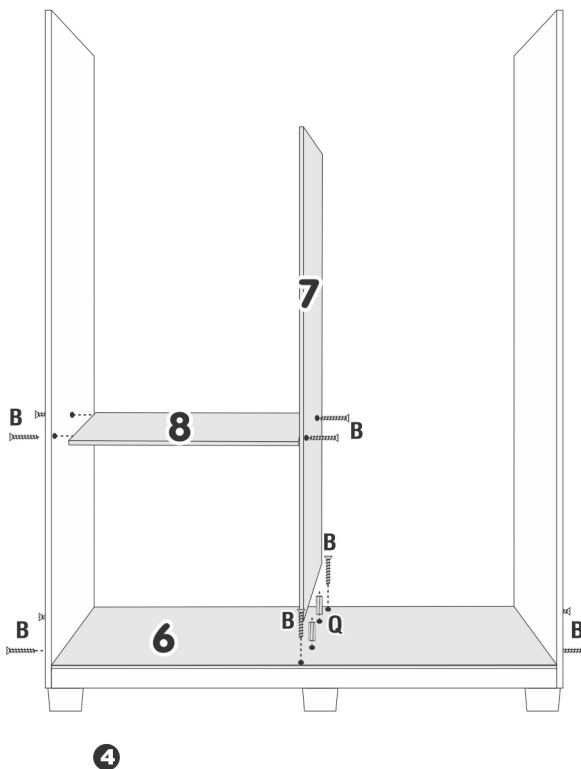

Sequência de Montagem

08 - Encaixar e Parafusar as peças 11 na peças 10;

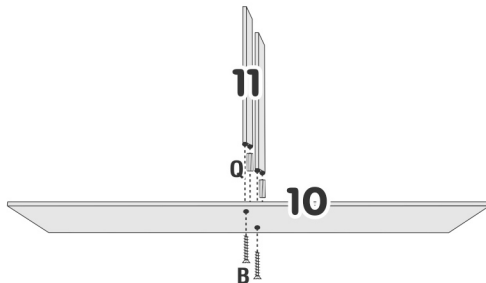
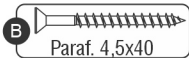

Sequência de Montagem

09 - Parafusar peça 8 nas peças 7;
10 - Parafusar peça 9 nas peças 7;
11 - Encaixar a peça 10 nas peças 7
Parafusar nas peças 1 e 4 em seguida parafusar nas peças 7;

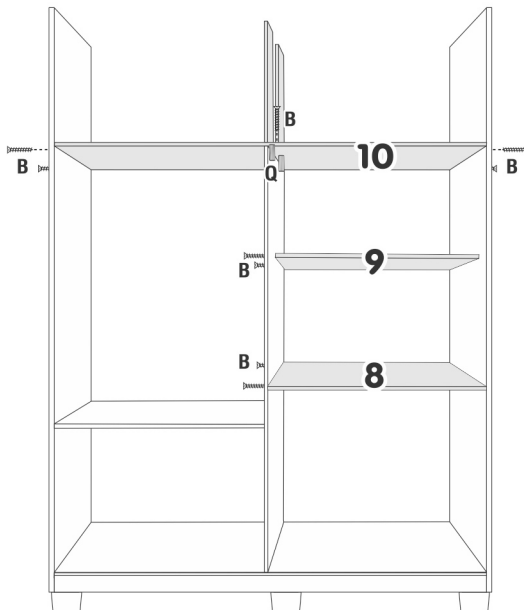

Sequência de Montagem

12 - Encaixar e parafusar peça 12 na peças 01 e 04 e 11.

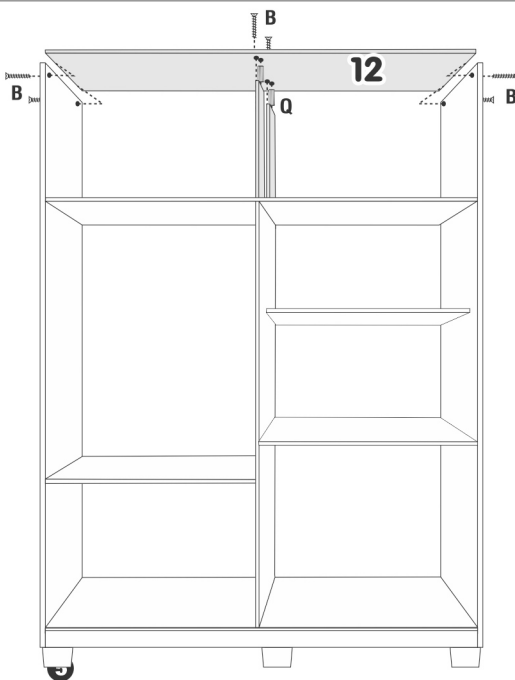
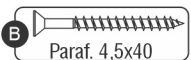

Sequência de Montagem

- 13 - Fixar peças 13 nas peças 01, 04 e também na peça 12.
- 14 - Parafusar Alongadores nas peças 07 conforme desenho.

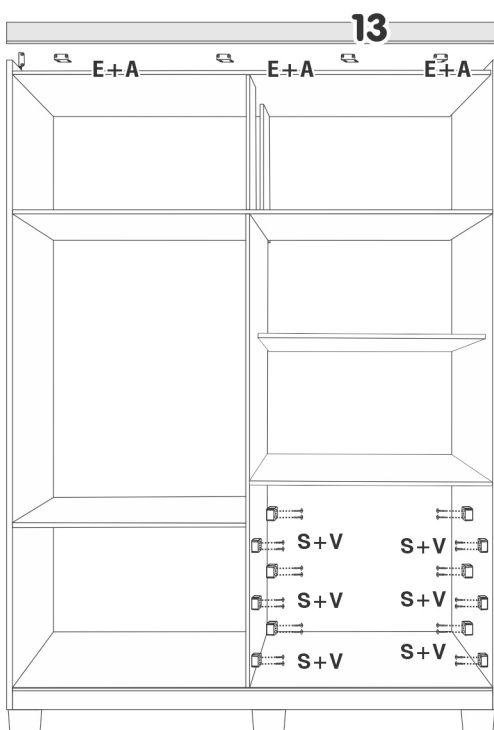
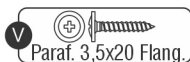

Sequência de Montagem

- 15 - Montar os cabideiros com os suportes.
- 16 - Parafusar as corrediças.

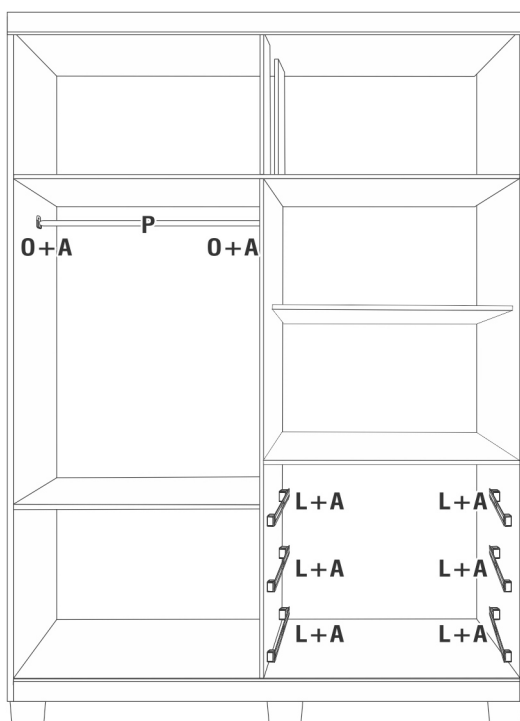
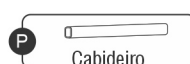
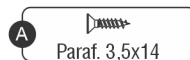

6

Seqüência de Montagem

17 - Parafusar as Costas 18.

OBS.: Acertar as costas para melhor esquadramento do móvel.



Fixador de Costas

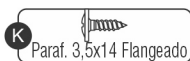

Paraf. 3,5x14 Flangeado

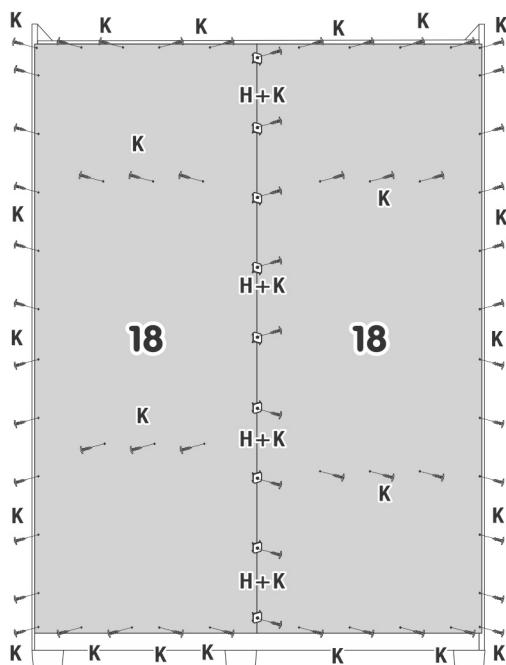

Seqüência de Montagem

18 - Montar e fixar as Portas 19.

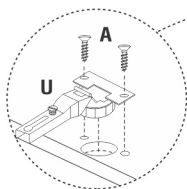

Paraf. 3,5x14

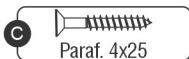

Paraf. 4x25

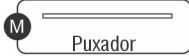

Puxador



Dobradiça Pressão



Calço

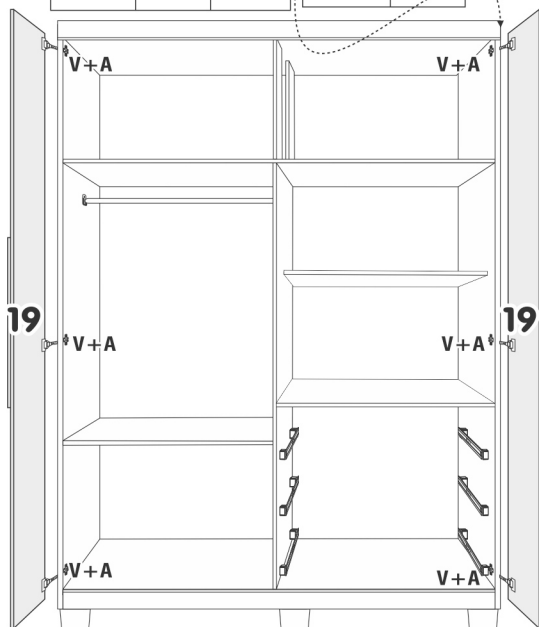
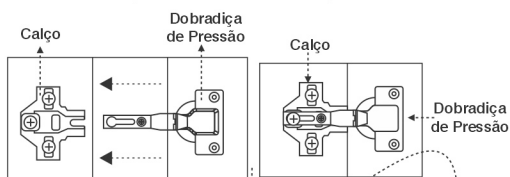
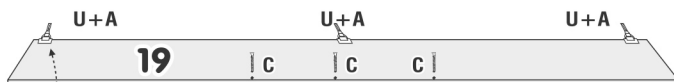

7

Sequência de Montagem

- 19 - Parafusar as cantoneiras nas peças 15;
- 20 - Parafusar as peças 15 na peça 14 colocando cola nas cavilhas;
- 21 - Parafusar a peça 16 nas peças 15;
- 22 - Parafusar peça 17 nas peças 15 e 16 conforme desenho abaixo, ajustando para melhor esquadramento da gaveta;
- 23 - Parafusar as corredeiras na lateral da peça 15;

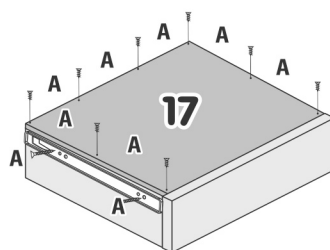
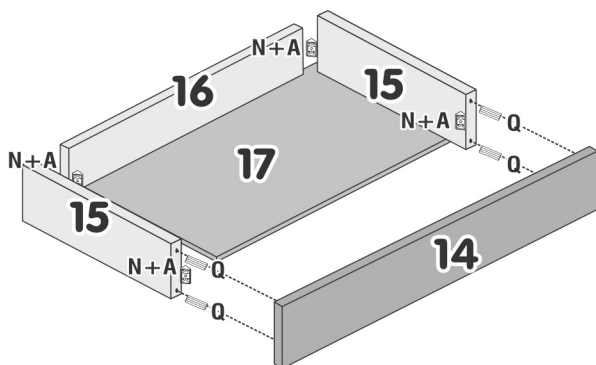
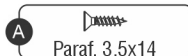

Benetil

Móveis

Av. Jesus Candian, 395 - B. Mangueira Rural

Telefax (32) 3539-5350

CEP 36500-000 - Ubá - Minas Gerais

www.benetil.com.br